

KONICA MINOLTA

bizhub 651i / 551i / 451i



**bizhub
i-SERIES**
SECURE YOUR RESOURCES
RETHINK EASE OF USE



bizhub i-Series
A3 Monochrome Multifunctional Printers

651i
BW 65 PPM

551i
BW 55 PPM

451i
BW 45 PPM

Giving Shape to Ideas

SECURE+ SIMPLE

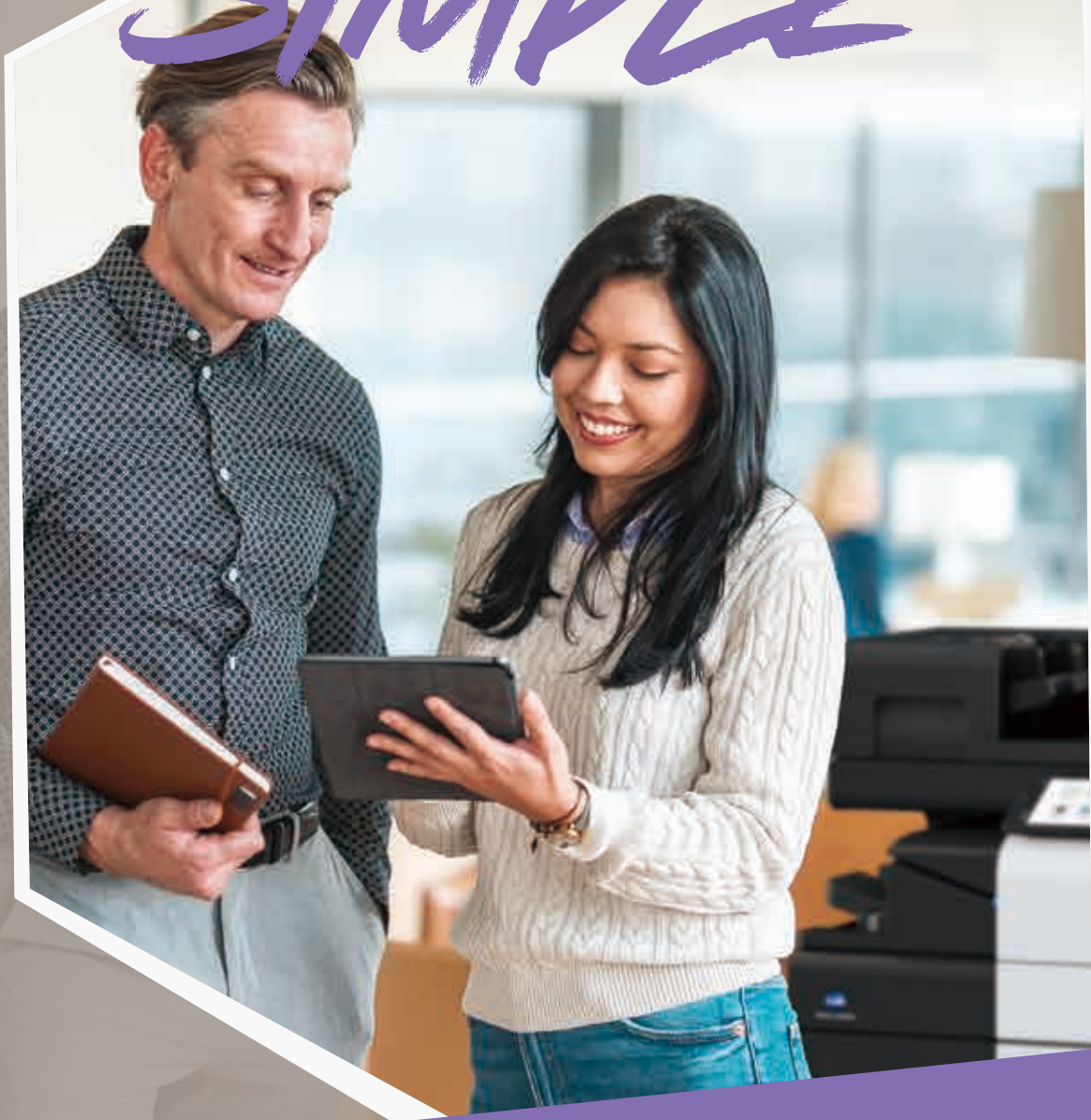

The new bizhub i-Series secures your business, and is easy to use.

The digital revolution continues to change the way we do business. We require the freedom to readily access data to keep work flowing at the speed business demands. Unfortunately, this can lead to a less secure environment if you're not vigilant. That's why Konica Minolta developed the new bizhub i-Series: to keep you in touch with all of your vital resources in a secure and simple-to-use environment.

From threat notification to proactive security, the new bizhub i-Series is designed to look after your data so you can concentrate on the job at hand with peace of mind. Seamless and productive, the bizhub i-Series has it all.

Empower your business.

SECURITY

- Advanced virus protection and reporting
- Proactive security management
- GDPR-ready for privacy standards compliance

PRODUCTIVITY

- High-speed production and finishing
- Intuitive design for a user-friendly experience
- Supports external applications and remote access

EFFICIENCY

- High operability with standardised interface
- Remote and predictive maintenance
- Intelligent Media Sensor to prevent downtime



CUSTOMISE YOUR BUSINESS



A secure and intuitive workplace is what the new bizhub i-Series brings to your business. Thanks to Konica Minolta MarketPlace, you have access to a constantly evolving array of specialised applications to tailor your bizhub MFP to your office work style and needs. Applications on the platform are constantly being upgraded and developed to stay ahead of the dynamic demands of today's business.

LIFE SHOULD BE SIMPLE



Customise your bizhub i-Series to provide streamlined access to frequently used tasks. The intuitive UI further facilitates efficiency by minimising screen transitions.

Simply easy

A new, simplified user interface, no hard keys* and haptic feedback make the operation panel intuitive to users familiar with smart devices. By concentrating on frequently used functions, screen transitions are minimised, making operation easy and convenient.

*For hard keys, install key pad KP-102.

10.1-inch touch panel

Developed for ease of use, the large-size, multi-touch operation panel provides smooth interaction with the new bizhub i-Series. Thanks to smart-tablet-like usability, the panel delivers intuitive operation, enhanced legibility and efficient workflow.



Customise to optimise

Create folders on the home screen to group functions for ease of use. Increase accessibility for a wider range of users by sorting copy or fax functions into separate folders.

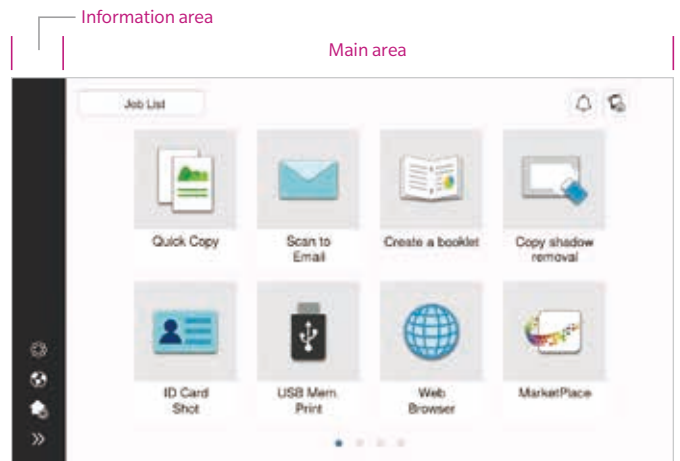

Quick Copy screen

The Quick Copy screen easily executes the intended task with minimal screen transitions

- Large buttons allow easy browsing and intuitive operation.
- Options are displayed in a list and can be changed with just one touch.

Choose your style

Switch between two user interface setups to match your office needs. Basic Style features streamlined operation with a customisable choice of intuitive copy functions, while Classic Style displays conventional settings and functions for more advanced needs.

Home screen

The screen is divided into an Information Area and a Main Area which are customisable.

- Information Area: displays information such as settings menu buttons, ID button, and user name while logged in.
- Main Area: access to functions such as copying, faxing and scanning.



Made for everyone

Freely adjust the tilt of the new bizhub i-Series operation panel up to 90 degrees to maximise ease of use for every user.



Functions that simplify jobs

Convenient functions like ID Card Shot are easy to access and even easier to use. Scan both sides and consolidate double-sided documents such as IDs onto a single sheet in just a few easy steps.



Make a booklet like a pro

Simple-to-follow steps guide you through the process of creating a booklet, such as a corporate profile or in-house magazine.

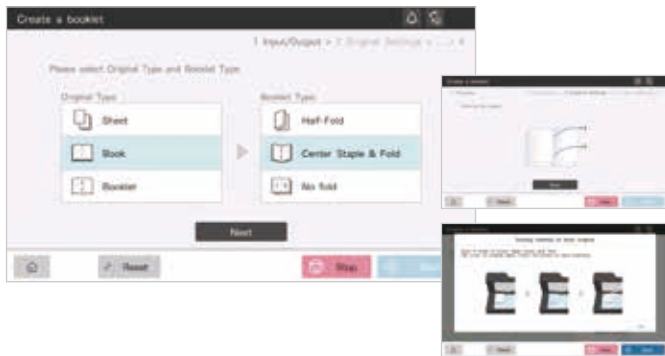

Smarter functions save you time

When you copy or scan a document with the cover open, smart functions like Non-image Area Erase automatically remove shadows from copies of thick documents such as books.

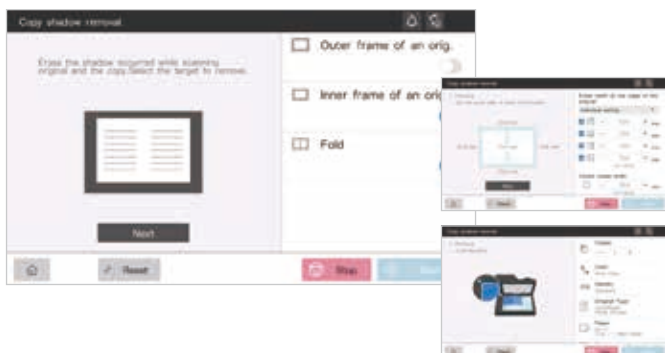

Indicator lights

LED lights on the front of the new bizhub i-Series indicate data transmission and remind users to pick up their printed documents while gently harmonizing with the office environment.



Blue LED

Flashing: receiving data
Lit: processing data

Orange LED

Flashing: low paper supply
Lit: empty tray

A voice to guide you

Voice guidance reads aloud fax numbers and describes major functions, keys and key-related operation to facilitate usability.

Available only in enlarged display mode on copy, fax and scan screens. Requires i-Option LK-104-v3, key pad KP-102 and device connection I/F kit EK-608 or EK-609.

Be mobile and productive

install the bizhub Remote Access app on Android or iOS devices connected to the same network as your bizhub i-Series to access an interface similar to the one on the operation panel. Enjoy MFP functions remotely without needing to interact with the operation panel or be standing in front of the MFP.

bizhub Remote Access is available on Google Play and App Store for free. The MFP operation panel cannot be used when bizhub Remote Access is in use.



Touch panel that's sensitive to your needs

The panel can be operated while wearing gloves, greatly reducing the risk of passing germs or infections in the office via hands or fingers. This feature is handy for environments where gloves are often worn, such as spas or salons.

START WITH THE BASICS

| COPY & PRINT |

Equipped with advanced features that revolutionise workflow and productivity, the new bizhub i-Series takes its roots seriously. Sure it can serve as an IoT device, but it's also a powerful performer for copy and print work.



Ready when you are

The new bizhub i-Series is fast and always ready to help you out. Warm-up time is less than 13 seconds for all of the i-Series MFPs. First Copy Out Time, the time it takes to output the first print, and panel reset time are also speedy to keep you productive.

| | 751i | 651i | 551i | 451i | 361i | 301i |
|---------------------|--------------------|--------------------|--------------------|--------------------|--------------------|--------------------|
| First Copy Out Time | 2.8 seconds | 2.8 seconds | 3.3 seconds | 3.8 seconds | 4.6 seconds | 5.0 seconds |
| Warm-up time | 13 seconds or less | 12 seconds or less | 12 seconds or less | 12 seconds or less | 11 seconds or less | 11 seconds or less |
| Panel reset time | About 1.5 seconds | | | | | |

High-quality output

Print at 1,200 dpi resolution for excellent reproduction of small font sizes and detailed design. Outstanding resolution capabilities ensure enhanced legibility of documents and sharp reproduction of fine lines.

Printing at 1,200 dpi slows printing speed.

Non-image Area Erase

Often times, making copies from odd-size or thick materials can produce unwanted shadows on the outside of the image. Non-image Area Erase automatically detects the document area and eliminates the shadow or dark areas surrounding the image. This is ideal for scanning receipts and multiple pages from thick books with the document cover open.

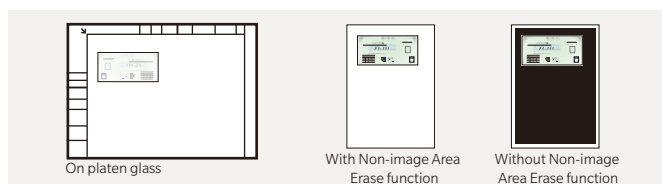

Easy-to-use paper trays

The lightweight paper trays on the new bizhub i-Series open and close smoothly with a light press or pull motion. Moreover, in the case of a paper jam, the paper trays can be easily removed to fix the jam.



Custom-size paper is just as easy

All of the new bizhub i-Series MFPs offer standard compatibility for custom-size paper on two front-loading paper trays. Universal Tray 1 can hold up to 200 post cards or 70 envelopes for easy printing without having to use the side-loading manual feed tray, saving space and increasing efficiency. Universal Paper Tray 2 can handle paper sizes from A5 to SRA3.

Automatic copy area detection

Non-standard-size documents placed on the platen glass or in the ADF are automatically measured and the size can be registered and saved for future use. This function is ideal for businesses that constantly handle odd-size documents such as tickets or vouchers.

Banner printing

The new bizhub i-Series MFPs can easily take over various printing operations that previously had to be outsourced, such as POS materials or banners. Supports extra-long printing up to 1,200 mm and paper widths from 90 mm to 297 mm.

MK-730 Banner Print Guide is recommended.

Print from the in-panel web browser

Websites can be displayed on the operation panel and printed directly. Specify pages of web-hosted PDF files to print out only what you need. Convenient for quickly printing maps or company contacts before heading to an appointment.



Print directly from USB

A standard USB port is located to the right of the new bizhub i-Series operation panel. When a USB memory device is inserted, options will automatically appear on the operation panel, allowing you to print directly or save items to the MFP's Box in a few easy steps.

Some USB devices may not be supported. Supported file formats: PDF, compact PDF, JPEG, TIFF, XPS, compact XPS, OOXML (.docx, .xlsx, .pptx).



Email RX Print

Print files by attaching them to an email and sending to your MFP's email address.

Supported file formats: PDF, compact PDF, JPEG, TIFF, XPS, compact XPS, OOXML (.docx, .xlsx, .pptx). Requires i-Option LK-110 v2.

Security with Virtual LAN (VLAN) compatibility

Connect to multiple VLAN networks to keep data isolated between networks, without affecting usability. Ideal for offices that secure client's critical data, or for businesses with internal and external networks, company-only and guest networks or shared offices where MFPs are used by multiple groups.

For more details contact your authorized Konica Minolta retailer.

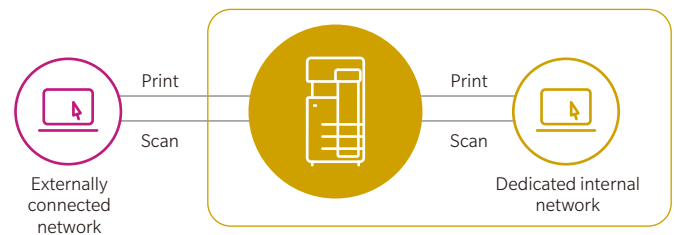

Other copy functions

- Image Quality Mode to match the original (text, text/photo, photo, faint original, map, copied original)
- Output Mode that matches application (double-sided printing, page aggregation, repeating, grouping, sorting, shifting, booklets, binding margin)
- Diverse Original Document Scan Modes (continuous scan, mixed originals, binding margin, original loading direction, thin paper, Z folded original, dust reduction mode, programmed jobs, blank original removal)
- Copy Mode can be set according to objective (book original, consecutive page copying, index originals, catalogue originals)
- Selectable Layout Adjustment (enlarge/reduce, consecutive enlargement copying, image storage method, mirror imaging, image shift, auto image rotation)
- Page Insertion is handy for adding a coversheet, OHP film, insert sheet, chapter separator, insertion page, among others
- Image Additions allows you to easily add date/time, page number, stamp, watermark, head/footer, overlay or registered overlay
- Frame Erase & Erase Outside detect and copy only what you need
- Copy Security functions include Copy Protect, Repeat Stamp, Copy Guard*, Password copy*

*Requires optional Security Kit SC-509.

Other print functions

- Supports BMLinkS which connects seamlessly with office equipment
- My Tab Function customises your tab with frequently used settings
- Printing to Tab Paper (index paper)
- Carbon Copy Mode prints the original document and copy at the same time. Different coloured sheets can be loaded to various paper trays if necessary
- Capable of printing on SRA3 size which fits A3 layouts with trim marks
- Auto Trapping Function prints so that there is no white gap around images

Some functions are only available in Classic Mode.

DATA IS DATA

SCAN & FAX

Regardless of where it came from or how you got it, you need to be able to manipulate, send and save documents. High performance scan and fax functions are complemented with a host of tools to improve work efficacy.



Double your scanning performance

The new bizhub i-Series features a standard* Dual Scan Document Feeder (DSDF) that simultaneously scans both sides of each sheet, achieving speeds of up to 280 ipm, or 140 double-sided sheets per minute. Load up to 300 sheets at a time, reducing time and effort digitising documents. Automatic skew correction has been improved, correcting the angle of scanned documents to match the original and deliver more accurate scans with less skew.

*Available with optional DF-714 for 361i, 301i.



Multi-feed detection sensors

Ultrasonic waves detect air between pages feeding into the DSDF*. When an accidental multi-feed is detected, a preview of the scan is shown on the operation panel so the job can be restarted without restarting the job from the beginning.

*Available with optional DF-714 for 361i, 301i.

Easy sort & store for fax data

Received faxes can be sorted according to TSI (Transmitting Subscriber Identification) and stored digitally in the Box. Set automatic transfer to PC or email addresses or forward to the MFP's SMB shared folder to save time and effort distributing received documents. Make paperless operation easy with improved sorting and forwarding options.

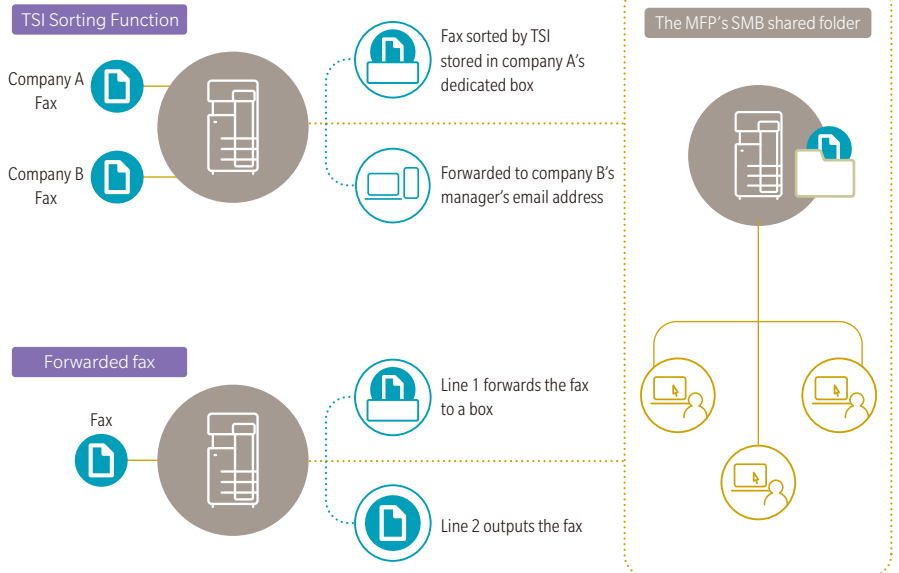

Easily manage faxes without printing

The Compulsory Memory Receive Box allows users to view faxes on the operation panel to manually select for transfer, printing or deletion, helping to reduce unnecessary output. It can be accessed directly from the home screen.

Requires i-Option LK-110 v2.

Removal of blank pages

The document feeder detects blank pages as you scan and removes them from the input data, saving you time in manual collating.

Handle big data with ease

The new bizhub i-Series can scan data and send an access URL to recipients via email. Scan to URL makes it easy to share large-size data which cannot be sent as email attachments, directly from the MFP.

Requires EM-908 Solid State Drive.

Send data directly to your email

Send scan data to your email inbox using Scan to Me directly from the home screen. And for enhanced protection, activate the authentication setting for secure transmission.

Efficient format conversion

Scanned originals can be converted into a variety of formats according to what you need them for. Save them to the new bizhub i-Series MFP's Box, a USB memory device, send to a PC or server by email, save to the SMB shared, FTP or Web DAV.

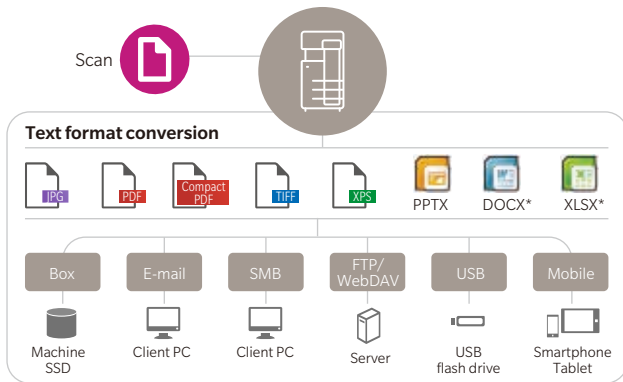

*Requires i-Option LK-110 v2.

Digitise paper documents

Scan and convert to PDF and OOXML formats. Ensure your digitised documents are suitable for their intended use by select the file format to best suit your needs.

Scan to PDF / Scan to OOXML image (with LK-110 v2 installed)

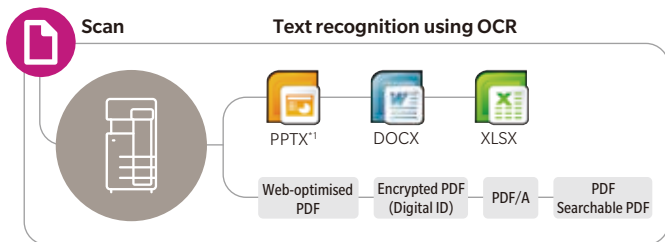

- Applying OCR to a document produces searchable text
- Microsoft Office, etc. enables reuse of images and text.

File conversion formats

| | LK-105 v4 | LK-110 v2 |
|--|-----------|-----------|
| | Optional | Optional |
| PDF/A (long-term archiving) | | ✓ |
| Web-optimised PDF (linearised PDF) | | ✓ |
| Encrypted PDF (digital ID) | | ✓ |
| Searchable PDF (OCR) | ✓ | ✓ |
| OOXML file (extension: docx/.xlsx/.pptx) conversion | | ✓*1 |
| OOXML file (extension: docx/.xlsx/.pptx) conversion +OCR | ✓*2 | ✓ |

*1 pptx conversion is a standard function, but the OCR function requires either LK-105 v4 or LK-110 v2.
*2 Only compatible with pptx.

ID Card Scan

Scan and send double-sided documents such as business cards, ID cards or driver's licences with both sides of the document combined in a single file or separated into different files.

Other main scan and fax functions

- Super G3 Standard achieves high-speed sending of approx. 2 seconds
- Direct Fax, paperless sending from a PC
- Convert received data into a Searchable PDF format*
*Requires i-Option LK-110 v2.
- Maximum 2-phone line Fax Function can aggregate multiple faxes
- W-NET FAX compatibility for broad Internet fax interchangeability
- IP Address Fax (T.38 FAX) reduces transmission costs*
*Requires i-Options LK-117 and FK-514.
- Address Storage for a maximum of 2,000 addresses (100 groups)
- Banner Scan scans long originals from the ADF

Cost Accounting & Recovery Tools Sold separately

Dispatcher Paragon



Provides a precise overview of all printing operations within your organisation for smart central accounting which maintains document security. Manage print costs by assigning role and department print quotas and assign codes to individual projects for accurate reporting of costs for your billing convenience. Control your environmental impact by assigning print budgets and enhance your digital workflow by adding optional intelligent scanning to cloud services including Dropbox, Box, Microsoft OneDrive for Business and Microsoft SharePoint Online, directly from the new bizhub i-Series control panel.

Task Automation Tools Sold separately

Dispatcher Phoenix



Dispatcher Phoenix automates digitised document processes from file aggregation to processing and distribution. By dividing processes via pre-set conditions, such as OCR processing, file renaming and barcode scanning, each document is automatically stored at a destination. This delivers one-touch execution of cumbersome tasks. Start times can be scheduled so that digitised tasks can be executed quickly and efficiently. Broad scalability and versatility, including connectivity with cloud services, enables creation of flexible workflows tailored to your business and office environment.

Some functions are only available in Classic Mode.

BETTER SAFE THAN SORRY

Our approach to security is proactive, preventing leaks and addressing security for both digital and paper documents. More importantly, we provide secure access and peace of mind without placing undue burden on your IT department.



Prioritising security

Nowadays, data protection is a major issue for any company. The new bizhub i-Series delivers advanced security settings through bizhub SECURE, a comprehensive range of services that provide greater protection for customer data stored in the SSD and the MFP's network settings.

Secure Print

Set a password when you send a document to print via the print driver. The protected document will not print and will be held securely at MFP until the correct password is entered on the operation panel. This feature is useful for confidential documents or when you want to give a limited group of users permission to receive copies.

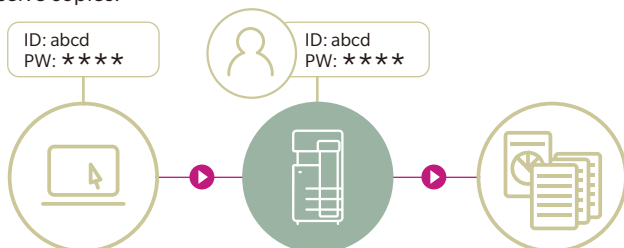

Secure printing using PC login ID

PC login profiles can be used as ID for secure printing. Users can output secure print jobs quickly and easily without needing to input their username and password at the machine each time.

Output tray light

A white LED light illuminates the output tray when documents have finished printing to remind users to collect their printed materials. This minimises the risk of forgotten documents and information leaks.



Encrypted SSD

Equipped with 256 GB, the SSD storage offers heightened security with excellent device compatibility and full-time encryption, maintaining a high level of protection.

Multiple ways to authenticate users

User authentication can be customized to best suit your office's scale and pre-existing systems. As well as multiple authentication options for every-day users, single sign-on (SSO) is also supported for enhanced operability without sacrificing security.

Main unit authentication

The new bizhub i-Series allows you to setup authentication using a username and password on the main unit. Set detailed usage restrictions including copy, print, scan and fax.*

*Requires FK-514 Fax Kit.

IC card authentication

Add the optional IC authentication device to add an additional layer of security with non-contact IC cards such as FeliCa. The device supports SSFC (Shared Security Formats Cooperation) specifications which enable integration of wider staff authentication systems with the new bizhub i-Series. Besides IC cards, authentication is possible using NFC-equipped Android devices registered with MFP via the Konica Minolta Mobile Print app.



Non-contact IC cards are compatible with FeliCa (IDm), SSFC, FCF, FCF (Campus) and MIFARE (UID).

Biometric authentication

If you prefer to avoid having to issue and replace IC cards, Biometric Authentication Device AU-102 is the choice for you. The device uses highly accurate registration of finger veins for quick and easy authentication that supports high-level security systems.

Requires AU-102 Authentication Device and WT-506 Working Table.

Security you can see

A virus scan icon has been added to the new bizhub i-Series home screen and other panel screens to show when virus scan is enabled. Additionally, you will now be notified via icon changes when a virus is detected or when a pattern file update fails. Use the MFP with greater peace of mind with the virus scan icon visible. Visibility also encourages prompt confirmation when viruses are detected or pattern file updates fail.

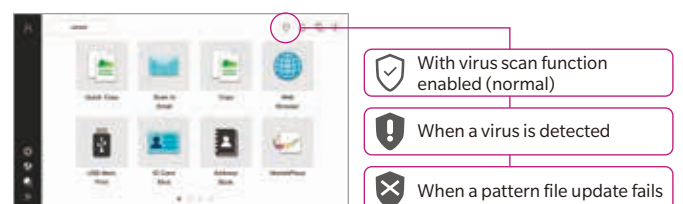

Virus scan powered by Bitdefender

Protect your network from threats with virus scanning that covers all data exchanged between the new bizhub i-Series and the external environment, including connections to PCs and mobile or USB devices. Periodic scans can also be scheduled or triggered when needed, covering the MFP's Box, SMB shared folder and SSD. Powered by Bitdefender, the pattern file is updated immediately upon powering up and checked every four hours. A virus scan icon on the home screen keeps users informed of the scan status.

Requires i-Option LK-116 and an internet environment.

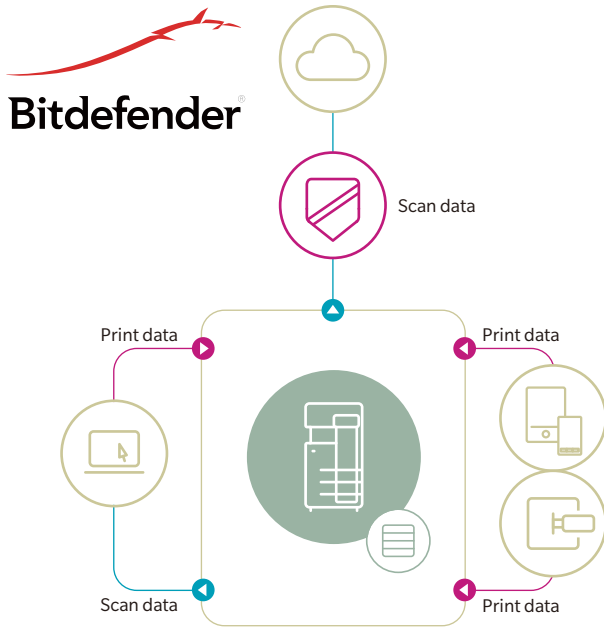

Stronger network security

The more powerful wireless LAN module features Wi-Fi WPA3 for increased security. TLS1.3 compatibility enables high-speed communication with reduced risk. The module also supports enhanced security for cloud connectivity.



Serverless printing in a ubiquitous network

Output print jobs from any bizhub MFP on your network after authentication. As a base unit for printing, your new bizhub i-Series works as a print server, enabling a low-cost, serverless printing system for up to 100 MFPs.

Requires i-Option LK-114 for all MFPs.

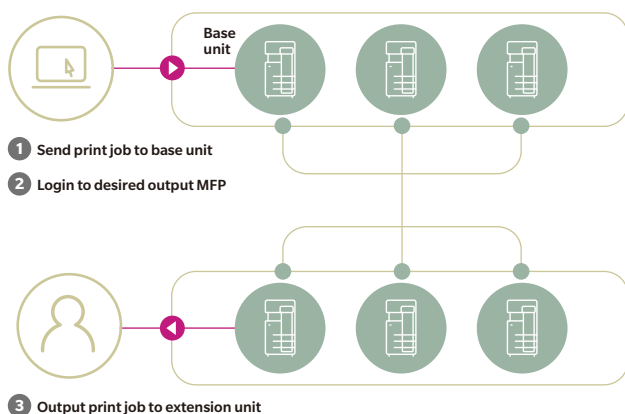

Security watermark

In addition to Copy Protect, Copy Guard, and Password Copy, you can print with a specialised security watermark embedded into documents which prevents secondary copying and leakage of confidential documents by unauthorized copying.

Requires SC-509 Security Kit. This function is only available in models equipped with Konica Minolta's security watermark function.

PDF Encryption

• Password

Encrypt PDFs with a password before distribution.

• Digital ID

Only authorised recipients with a private key can decrypt. This is more robust than previous public key systems.

When using Digital ID encryption, the email address (S/MIME send) to which the Digital ID has already been registered must be registered to the MFP's abbreviated address.

• Electronic signature

Electronic signatures certify the author of a document output from the new bizhub i-Series, guaranteeing the document has not been altered and is valid. Third party certifications can also be used.

When using electronic signatures, files should also be encrypted used with password or Digital ID.

High-level ISO/IEC 15408 compliance

The new bizhub i-Series complies with the Common Criteria for Information Technology Security Evaluation (ISO/IEC 15408). Konica Minolta is in the process of acquiring third-party certification from the Japan-based Information-technology Promotion Agency (IPA). IPA's HDC-PP v1.0 standard certifies that all equipment meets the latest requirements for security.

Information security-related certification obtained for this product (and this system) demonstrates compliance with certification requirements as a result of evaluations based on specified evaluation standards and methods, but does not assure that the product (or the system) is completely without weaknesses.

Other major security features

- SMTP authentication/POP before SMTP authentication enable security to be set when sending emails.
- SSL/TLS protocol enables encryption of data transmission between networks
- Storage Lock Password prevents unauthorised access to the SSD
- TPM (Trusted Platform Module) safely manages confidential information*

*Requires i-option LK-115v2.

FASEC 1-compliant fax security

- Double Address Input prevents erroneous transmission through input error
- Destination Number Confirmation Display prevents erroneous transmission due to incorrect dialling
- Dial Tone Detection function prevents erroneous transmission due to call collision
- Memory Receive & PC Forward prevents paper faxes from being left behind
- Transmission Result Report and Operation Panel Result Check enables verification of fax transmission

Konica Minolta's original fax security

- Send Approval Password function prevents erroneous transmission through thorough checking
- Recipient Confirmation (CSI matching) Send prevents erroneous transmission through wrong connection
- Voice Guidance when Sending reads out fax number before sending fax to prevent transmission*

*Requires i-Option LK-104v3, Key pad KP-102 and device connection EK-608 / EK-609.

- Designated Tray Paper Feed assists security management

WORK SMARTER, FINISH FASTER



A score of options to fit the needs of your business allow you to choose just the amount of output and finishing power you demand. Functions like the Intelligent Media Sensor reduce downtime and minimise waste.

As much paper as you need

The new bizhub 751i boasts a 3,650-sheet paper capacity with the standard paper trays and the manual feed tray. Other models have a standard capacity of 1,150 sheets. Add optional cabinets or large capacity units such as the PC-417 and LU-303 to boost paper capacity of all models to a maximum of 6,650 sheets of 80 g/m² paper or an impressive 7,615 sheets of 64 g/m² paper.

Paper Feed Cabinet

The PC-417 Paper Feed Cabinet comprises two large-capacity paper feed trays for A4 and B5 paper. Bringing the total number of front-loading paper feed trays to four, the cabinet supports continuous printing without the need to stop print jobs to replenish paper.

PC-417 is standard for the 751i and optional for the 651i, 551i, 451i, 361i, 301i



Max. 6,650 sheets
80 g/m²

Multi manual feed (Standard)
Max. A3
150 sheets

Universal tray (Standard)
Max. A3
500 sheets

Universal tray (Standard)
Max. SRA3
500 sheets

PC-417 (Standard for the 751i, optional for the 651i, 551i, 451i, 361i, 301i)
Max. A4 2,500 sheets

LU-205 (Option. Compatible with the 751i only.)
Max. SRA3
2,500 sheets

LU-303 (Option. Compatible with the 751i only.)
Max. A4
3,000 sheets

Max. 6,650 sheets
80 g/m²



Multi manual feed (Standard)
Max. A3
150 sheets

LU-207 (Option. Compatible with the 651i, 551i and 451i only.)
2,500 sheets

LU-302 (Option. Compatible with the 651i, 551i, 451i, 361i, 301i only.)
Max. A4
3,000 sheets

Universal tray (Standard)
Max. A3
500 sheets

Universal tray (Standard)
Max. SRA3
500 sheets

Options



Max. 3,650 sheets
PC-417 (standard for 751i, optional for 651i, 551i, 451i, 361i, 301i)
Max. A4 2,500 sheets

Max. 1,650 sheets



PC-116 (Option)
Max. A3
500 sheets

Max. 2,150 sheets



PC-216 (Option)
Max. A3
2 x 500 sheets

Max. 3,650 sheets



PC-416 (Option)
Max. A4
2,500 sheets

All paper volumes calculated using 80 g/m² paper unless otherwise indicated.

Automated to help you

With the new bizhub i-Series, paper type and size are detected and settings are automatically adjusted for optimised printing on various media types, including envelopes. The Intelligent Media Sensor prevents drops in print quality and reduces the burden on users to select the appropriate settings for new paper types and sizes. Requires optional IM-103 Intelligent Media Sensor.

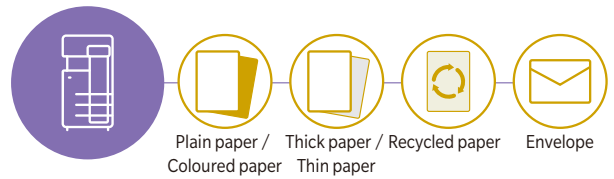

Manual stapling

Add an optional finisher to your setup to quickly re-staple original documents after copying or for easy stapling when staple settings have not been selected before printing. FS-539, FS-539SD, FS-540 or FS-540SD Finisher option required.



Smart-size finishing

Capable of handling print speeds up to 65 ppm, the new FS-542 inner finisher supports hole punching*, 45-degree and short-edge parallel corner stapling, and two-point side stapling, without adding to the MFP's footprint. With finishing capabilities comparable to a floor finisher, the FS-542 even handles offline manual stapling up to 50 sheets, making it ideal for the new bizhub i-Series (not available on the bizhub 751i).

*Requires punch kit PK-527.

Offline stapling

FS-P04 is the perfect solution for offices that need basic finishing capabilities but do not want to add a full-size finisher. This compact unit attaches to the optional working table of the new bizhub i-Series to support offline stapling.



Accommodates printing speed up to 65 ppm

Manual stapling up to 50 sheets (23-15/16 lb (90 g/m²))

The choice is yours

Power up the new bizhub i-Series with a range of multifunctional finishers that offer capabilities including booklet making, tri-fold, stapling and hole punching or choose the compact FS-542, the first inner finisher to support up to 65 ppm output.



Finishing Functions

| | | FS-540 ^{1,*2} | FS-540SD ^{1,*2} | FS-539 ^{1,*2} | FS-539SD ^{1,*2} | FS-542 | JS-508 / JS-506 ³ |
|--------------------------------------|--|--|---|-----------------------------------|--------------------------|-----------------------------------|------------------------------|
| Compatibility | 751i | ✓ | ✓ | ✓ | ✓ | — | — |
| | 651i | ✓ | ✓ | ✓ | ✓ | ✓ | — |
| | 551i / 451i | ✓ | ✓ | ✓ | ✓ | ✓ | ✓ |
| | 361i / 301i | — | — | ✓ | ✓ | ✓ | ✓ |
| Finishing Option | | FS-540 ^{1,*2} | FS-540SD ^{1,*2} | FS-539 ^{1,*2} | FS-539SD ^{1,*2} | FS-542 | JS-508 / JS-506 ³ |
| Offset sorting (Shift sort) function | Slightly offsets position of each set of pages when discharged | ✓ | ✓ | ✓ | ✓ | ✓ | ✓ |
| Stapling functions | Corner stapling | ✓ | ✓ | ✓ | ✓ | ✓ | — |
| | Corner stapling (parallel) ^{4,*5} Corner stapling (parallel) ⁴ Two-point stapling (side) | Thin / Plain (52 - 80 gsm) A4, B5: max. 100 sheets / B4: max. 65 sheets A3, A5: max. 50 sheets Plain (81-90 gsm) B4, A4, B5: max. 60 sheets / A3, A5: max. 50 sheets | Thin / Plain (52-90 gsm): max. 50 sheets Plain + / Thick (91-120 gsm): max. 30 sheets Thick (121-209 gsm): max. 15 sheets | — | — | — | — |
| Booklet function & folding functions | Saddle stitching | — | Max. 20 sheets | — | Max. 20 sheets | — | — |
| | Centre-fold Tri-fold (up to 3 sheets) | — | Max. 20 sheets | — | Max. 20 sheets | — | — |
| Z folding function | Z folding | Z folding unit ZU-609 52-90 gsm | — | — | — | — | |
| Hole-punching | Two-hole punch | Punch kit PK-526 Up to 300 gsm | — | Punch kit PK-524 Up to 300 gsm | — | Punch kit PK-527 Up to 157 gsm | — |
| | Upper two-hole punch | — | — | — | — | — | |
| Cover sheet & Insert sheet | Cover sheet | Post Inserter PI-507 or standard functions | — | Standard functions | — | Standard functions | Standard functions |
| | Insert sheet | — | — | — | — | — | |
| Job separation | Job separation | Job separator JS-602 | — | — | — | — | |

¹ All allows setting of a maximum of three output locations. For the FS-540 and FS-540SD, a maximum of four output locations can be set with Job Separator JS-602 installed. ² 751i requires Relay Transport Unit RU-519, other models require Relay Transport Unit RU-513 to be installed. ³ The JS-508 is an option for sorting by function for use on the 551i or 451i. The JS-506 is an option for sorting by function for use on the 361i or 301i. The sorting function simplifies output of a large number of print jobs. With the JS-506 or JS-508 installed, a finisher cannot be installed. The JS-602 is an option that requires the FS-540 or FS-540SD. ⁴ On the FS-540, FS-540SD, FS-539 and FS-539SD parallel stapling is only supported for A3, A4 portrait, A4 landscape, B5 portrait and A5 landscape orientations. Manual setting is required for A3 and A4 landscape. ⁵ The FS-542 does not support parallel stapling in this position.

GO WHERE YOU WANT

Business today is not centred around being at the office all day long. Whether at home or on the move, you are connected to your office and resources, and the new bizhub i-Series is there at your disposal.



Mobile connectivity

Connect with NFC-equipped Android devices

The NFC touch area on the front of the bizhub allows users to print from and scan to NFC-equipped Android devices using the Konica Minolta Mobile Print app. After registering the device to your bizhub i-Series using the app, simply hold the device over the NFC touch area to print a selected file. Scanned documents in the MFP can be saved to the device the same way. NFC Android devices can also be used for user authentication, allowing users to log in at the MFP by touching their device.

Wireless LAN environment required.

Connect with iOS devices

The iOS action button for printing is also supported, making data sharing from a large range of apps smooth and simple. iOS devices can also be used for user authentication, allowing users to log in at the MFP using Bluetooth LE.

Requires EK-609 Local Area Interface Kit and Wireless LAN.

Secure and simple

Create a local wireless LAN environment with only the new bizhub i-Series, separate from your office LAN, with Simple Access Point (AP) Mode. Bypassing the main office LAN allows secure connection to mobile devices or laptops brought in from outside.

Requires UK-221 Upgrade Kit.

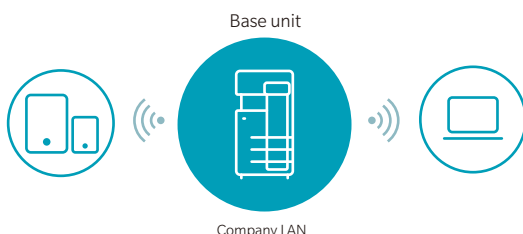

Scalable to meet your needs

Konica Minolta MarketPlace is pre-installed on the operation panel, giving users access to a wide range of convenient applications to tailor the functionality of the new bizhub i-Series.

Compatible mobile print services



Konica Minolta Mobile Print

A simple and intuitive user interface that enables fast, secure connection to mobile devices. Once a mobile device is registered, users can send, receive and share data securely, as well as print documents and images directly from their device. Authentication Print and Secure Print are also supported for worry-free printing of confidential documents.



AirPrint

Apple's native printing system is supported for iOS and Mac OS devices. Connect to the new bizhub i-Series via wireless LAN without having to install any applications or printer drivers on the device.



Mopria Print Service & Mopria Scan

Print from and scan to Android devices on your Wi-Fi network using Mopria Alliance apps.

Worldwide Remote Service Platform

The new bizhub i-Series MFPs feature intelligent self-diagnostic and remote maintenance capabilities. This allows smart prediction of optimum parts and consumables replacement for minimised downtime.

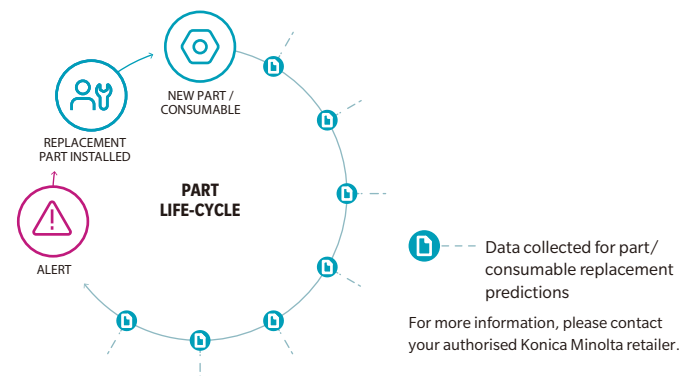

bizhub Connectors

Connect the new bizhub i-Series directly to selected cloud services^{*1} and SharePoint corporate internal servers using the dedicated Connector app. Authenticate cloud services via the bizhub operation panel to save authentication details and access cloud services with ease.

bizhub Connector^{*2} offers 3 applications

bizhub Connector S-1 for Microsoft SharePoint Server

bizhub Connector G-1 for Google Apps

bizhub Connector E-1 for Evernote

*1 Google Drive, Gmail, and Evernote.

*2 Requires a separate set-up fee.

THINK ABOUT IT, WE DO

At Konica Minolta, we are in the business of making business run better. And that's never at the expense of sustainability or environmental responsibility.



Made responsibly

Konica Minolta's proprietary chemical processing is enhancing the strength and flame resistance of recycled plastics. The new bizhub i-Series is constructed with more than 30% recycled materials, with 88% of the outer casing made from recycled plastic.

Energy conscious

Power-saving logic on the new bizhub i-Series has been improved, dropping sleep mode power consumption to an industry-leading 0.5 W, reducing environmental impact and total cost of ownership (TCO).

Sustainability is a priority

Green Products Certification is Konica Minolta's in-house evaluation system for environmental performance and sets a rigorous standard for sustainability and environmental consideration. All MFPs in the new bizhub i-Series have been certified as Green Products.

<https://www.konicaminolta.com/about/csr/environment/activity/solution.html>

Good Packaging Award

New bizhub i-Series MFPs are delivered protected by award-winning styrofoam Air Cushion packaging materials. Cushions are carefully distributed around the MFP for maximum protection and minimum waste.



Setting the tone for smart energy use

Konica Minolta's high-performance polymerised Simitri V toner requires less heat for fixing, using a temperature around 15° C lower than previous models, saving energy on every print. Simitri V toner also uses less energy during the manufacturing process.

Low energy consumption

Energy efficient features on the new bizhub i-Series mean that typical energy consumption (TEC) easily clears the values stipulated in the International Energy Star Program Version 3.0. Improved thermal insulation and a high-efficiency heater prevent heat loss and reduce warm up times for efficient operation and minimised environmental impact.

100% renewable energy

Konica Minolta is contributing to reducing global CO₂ by using certified renewable electricity and solar power throughout production. All Konica Minolta Group MFP production facilities use 100% renewable energy. Work is currently under way to expand the use of renewable energy at all sales bases around the world.

Environmental standards

Konica Minolta products are designed and manufactured in compliance with the leading global environmental standards.



The Blue Angel
(Germany)



Green Purchase
(Japan)



Eco Mark (Japan)



RoHS
対応
Restriction of Hazardous
Substances
(EU)

PRODUCT SPACE REQUIREMENTS

bizhub 651i/ 551i/ 451i standard configuration

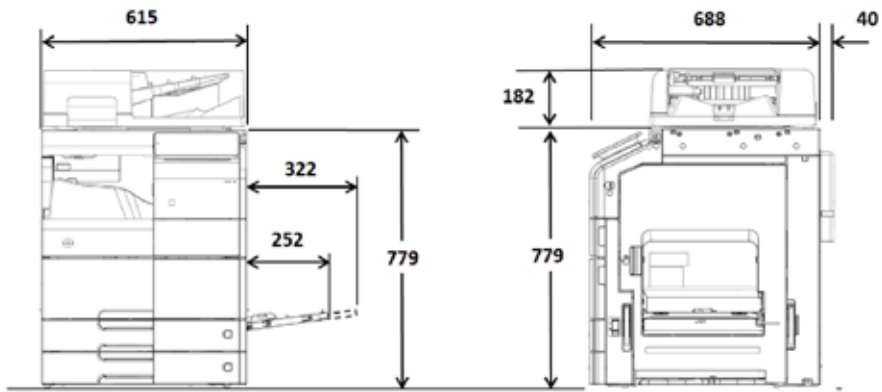

bizhub 651i/ 551i/ 451i

PC-216(PC-116/PC-416/PC-417/DK-516)+FS-539+LU302+MK-730

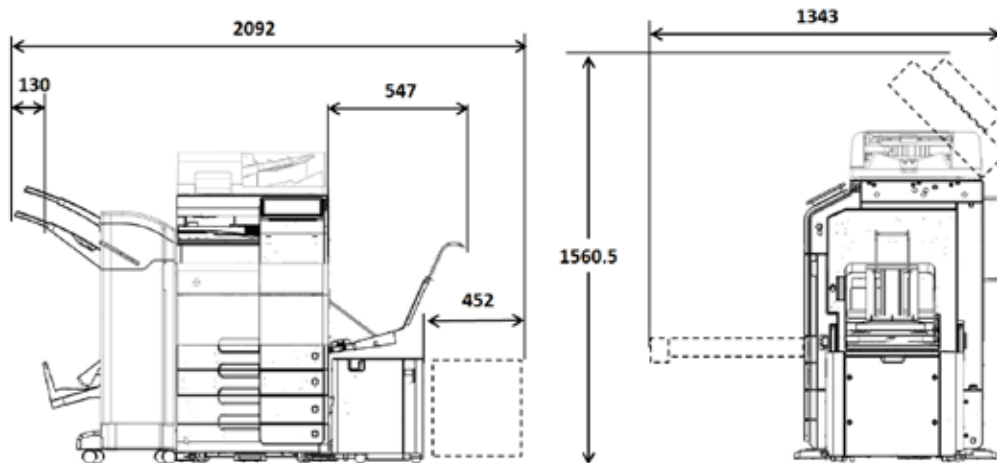

bizhub 651i/ 551i/ 451i

PC-216(PC-116/PC-416/PC-417/DK-516)+LU207+FS-540+JS-602+CU-102+MK-730

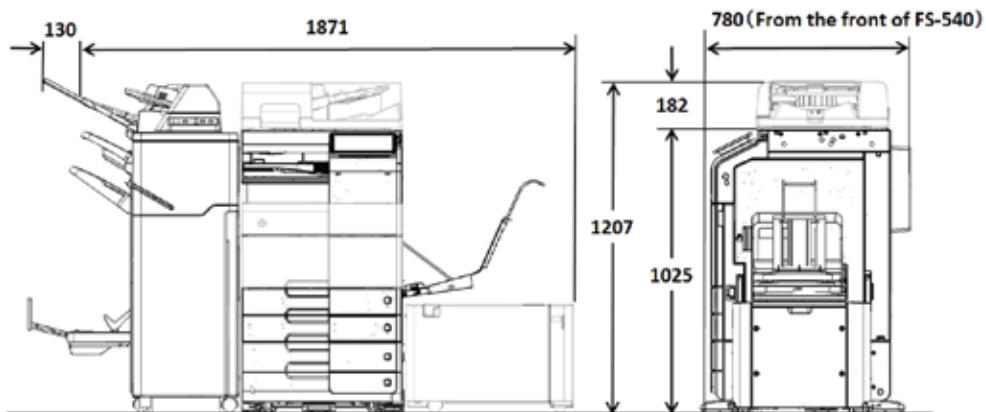

CUSTOMER BENEFITS



Intuitive operability
Operate the bizhub like a smartphone or tablet with fully customised user interface



Security
Secure network integration, data encryption, storage data overwrite, and advanced user authentication



Application ecosystem
Enhanced efficiency thanks to Konica Minolta's extensive applications portfolio



Productivity
Reliability, high-speed scanning and printing, combined with powerful finishing functions



Services
Efficient printer fleet management, including automatic consumables delivery, pro-active maintenance and remote setup



Sustainability
Numerous eco features reduce energy consumption and costs

OPTIONS

1 ENHANCED FEATURES

- Voice guidance
LK-104v3
- OCR text recognition
LK-105v4
- Barcode fonts
LK-106
- Unicode fonts
LK-107
- OCR A and B fonts
LK-108
- Document converter pack
LK-110v2
- ThinPrint® client
LK-111
- Serverless pull printing
LK-114
- Trusted Platform Module
LK-115v2
- Antivirus
LK-116
- FOIP activation
LK-117



2 CONNECTIVITY

- Fax board
FK-514 x2
- Wireless LAN
UK-221
- USB I/F kit
EK-608 OR
- USB I/F kit with bluetooth
EK-609
- Biometric authentication
AU-102 OR
- Card authentication
ID card reader OR
- Mount kit
MK-735

3 OTHERS

- Working table
WT-506
- Offline Stapler
FS-P04
- 10-Key pad
KP-102
- Security kit
SC-509
- Replacement SSD
EM-908
- Keyboard holder
KH-102
- Air cleaning unit
CU-102

4 MEDIA INPUT

- Intelligent media sensor
IM-103
- 1x Universal tray
PC-116, 500x1 OR
- 2x Universal tray
PC-216, 500x2 OR
- Large capacity tray
PC-416, 2500x1 OR
- Large capacity tray
PC-417, 1500x1 + 1000x1 OR
- Copier desk
DK-516
- Large capacity tray
LU-302, 3000x1 OR
- Large capacity tray
LU-207, 2500x1
- Banner tray
MK-730

5 MEDIA OUTPUT

- | | | | |
|--|--|--|---|
| Output tray OT-513 OR | Inner finisher FS-542 OR | Staple finisher FS-539 OR | Staple finisher FS-540 OR |
| Job separator ¹ JS-508 OR | Punch kit for FS-542 PK-527 | Relay unit RU-513 OR | Relay unit RU-513 OR |
| | | Booklet finisher FS-539SD OR | Booklet finisher FS-540SD OR |
| | | Relay unit RU-513 OR | Relay unit RU-513 OR |
| | | Punch kit for FS-539/SD PK-524 | Punch kit for FS-540/SD PK-526 OR |
| | | | Job separator for FS-540/SD JS-602 OR |
| | | | Post inserter for FS-540/SD PI-507 OR |
| | | | Z-fold unit for FS-540/SD ZU-609 |

LEGEND

- Mandatory option
- Option
- This option can only be installed with the respective option above it

¹ Supports bizhub 551i/451i

FINISHING FUNCTIONALITIES



- Corner stapling
- Two-point stapling
- Two-hole punching
- Four-hole punching
- Duplex
- Combined mixplex/mixmedia
- Half-fold
- Sheet insertion
- Letter-fold
- Booklet
- Offset sorting
- Z-fold
- Banner printing
- Corner Stapling (offline)

DESCRIPTION

ENHANCED FEATURES

| | |
|----------------------------------|--|
| LK-104v3 Voice guidance | Supports voice guidance |
| LK-105v4 OCR text recognition | Searchable PDF and PPTX |
| LK-106 Barcode fonts | Supports native barcode printing |
| LK-107 Unicode fonts | Supports native Unicode printing |
| LK-108 OCR A and B fonts | Supports native OCR A and B font printing |
| LK-110v2 Document converter pack | Generates various file formats incl. DOCX, XLSX and searchable PDF |
| LK-111 ThinPrint® client | Print data compression for reduced network impact |
| LK-114 Serverless pull printing | Secure and Follow Me printing solution requiring no server application |
| LK-115v2 Trusted Platform Module | Trusted Platform Module for protection of data encryption and decryption |
| LK-116 Antivirus | Bitdefender® antivirus provides real time scanning of all incoming and outgoing data |
| LK-117 FOIP activation | Fax over IP networks (T.38), requires fax kit |

CONNECTIVITY

| | |
|---------------------------------|---|
| FK-514 Fax board | Super G3 fax, digital fax functionality |
| UK-221 Wireless LAN | Wireless LAN and wireless LAN Access Point Mode |
| EK-608 USB I/F kit | USB keyboard connection |
| EK-609 USB I/F kit | USB keyboard connection; Bluetooth |
| AU-102 Biometric authentication | Finger vein scanner |
| ID card reader | Various ID card technologies |
| MK-735 Mount kit | Installation kit for ID card reader |

OTHERS

| | |
|------------------------|--|
| WT-506 Working table | Authentication device and/or offline stapler placement |
| FS-P04 Offline Stapler | Offline stapler, 20 sheets stapling |
| KP-102 10-Key pad | For use instead of touchscreen |
| SC-509 Security kit | Copy guard function |
| EM-908 Replacement SSD | 1 TB SSD to increase storage space |

OTHERS

| | |
|--------------------------|--|
| KH-102 Keyboard holder | To place USB keyboard |
| CU-102 Air cleaning unit | Improving indoor air quality by reduced emission |

MEDIA INPUT

| | |
|---------------------------------|--|
| IM-103 Intelligent media sensor | Autodetects paper weight and type |
| PC-116 1x Universal tray | 500 sheets, A5-A3, 52-256 g/m ² |
| PC-216 2x Universal tray | 2x 500 sheets, A5-A3, 52-256 g/m ² |
| PC-416 Large capacity tray | 2,500 sheets, A4, 52-256 g/m ² |
| PC-417 Large capacity tray | 1,500 + 1,000 sheets, A5-A4, 52-256 g/m ² |
| DK-516 Copier desk | Provides storage space for print media and other materials |
| LU-302 Large capacity tray | 3,000 sheets, A4, 52-256 g/m ² |
| LU-207 Large capacity tray | 2,500 sheets, A4-SRA3, 52-256 g/m ² |
| MK-730 Banner tray | Multipage banner feeding |

MEDIA OUTPUT

| | |
|------------------------------------|---|
| OT-513 Output tray | Output tray used instead of finisher |
| JS-508 Job separator | Separation of fax output; etc. |
| FS-542 Inner finisher | 50-sheet stapling, 500 sheets max. output |
| PK-527 Punch kit for FS-542 | 2/4 hole punching, autoswitching |
| FS-539 Staple finisher | 50 sheets stapling; 3,200 sheets max. output |
| FS-539SD Booklet finisher | 50 sheets stapling; 20 sheets booklet finisher; 2,200 sheets max. output |
| PK-524 Punch kit for FS-539/SD | 2/4 hole punching; autoswitching |
| FS-540 Staple finisher | 100 sheets stapling; 3,200 sheets max. output |
| FS-540SD Booklet finisher | 100 sheets stapling; 20 sheets booklet finisher; 2,700 sheets max. output |
| PK-526 Punch kit for FS-540/SD | 2/4 hole punching; autoswitching |
| RU-513 Relay unit | For FS-539/SD or FS-540/SD installation |
| JS-602 Job separator for FS-540/SD | Separation of fax output; etc. |
| PI-507 Post inserter for FS-540/SD | Cover insertion; post finishing |
| ZU-609 Z-fold unit for FS-540/SD | Z-fold for A3 prints |

TECHNICAL SPECIFICATIONS

SYSTEM SPECIFICATIONS

| | 651i | 551i | 451i |
|-----------------------------|---|--------------|--------------|
| System speed A4 | Up to 65 ppm | Up to 55 ppm | Up to 45 ppm |
| System speed A3 | Up to 32 ppm | Up to 27 ppm | Up to 22 ppm |
| Autoduplex speed A4 | Up to 65 ppm | Up to 55 ppm | Up to 45 ppm |
| 1st page out time A4 | 2.8 sec. | 3.3 sec. | 3.8 sec. |
| Warm-up time | Approx. 12 sec. ¹ | | |
| Imaging technology | Laser | | |
| Toner technology | Simitri V toner | | |
| Panel size/resolution | 10.1" / 1024 x 600 | | |
| System memory | 8,192 MB (standard/max) | | |
| System hard drive | 256 GB SSD (standard) / 1 TB SSD (optional) | | |
| Interface | 10/100/1,000-Base-T Ethernet; USB 2.0; Wi-Fi 802.11 b/g/n/ac (optional) | | |
| Network protocols | TCP/IP (IPv4 / IPv6); SMB; LPD; IPP; SNMP; HTTP(S); Bonjour | | |
| Automatic document feeder | Up to 300 originals; A6-A3; 35-210 g/m ² ; Dualscan ADF | | |
| ADF double feed detection | Standard | | |
| Printable paper size | A6-SRA3; customized paper sizes; banner paper max. 1,200 x 297 mm | | |
| Printable paper weight | 52-300 g/m ² | | |
| Paper input capacity | 1,150 sheets / 6,650 sheets (standard/max) | | |
| Paper tray input (standard) | 1x 500; A6-A3; custom sizes; 52-256 g/m ² 1x 500; A5-SRA3; custom sizes; 52-256 g/m ² | | |
| Paper tray input (optional) | PC-116 500 sheets; A5-A3; 52-256 g/m ² PC-216 2x 500 sheets; A5-A3; 52-256 g/m ² PC-416 2,500 sheets; A4; 52-256 g/m ² PC-417 1x1,500 + 1x 1,000 sheets; A5-A4; 52-256 g/m ² | | |

SYSTEM SPECIFICATIONS

| | |
|--------------------------------|---|
| Large capacity tray (optional) | LU-302 3,000; A4; 52-256 g/m ² LU-207 2,500; A4-SRA3; custom sizes; 52-256 g/m ² |
| Manual bypass | 150 sheets; A6-SRA3; custom sizes; banner; 60-300 g/m ² |
| Finishing modes (optional) | Offset; Group; Sort; Staple; Staple (offline); Punch; Half-fold; Letter-fold; Booklet; Post insertion; Z-fold |
| Automatic duplexing | A6-SRA3; 52-256 g/m ² |
| Output capacity | Up to 250 sheets / up to 3,300 sheets (standard/max) |
| Stapling | Max. 100 sheets or 98 sheets + 2 cover sheets (up to 300 g/m ²) |
| Stapling output capacity | Max. 200 sets |
| Letter fold | Max. 3 sheets |
| Letter fold capacity | Max. 50 sets; unlimited (without tray) |
| Booklet | Max. 20 sheets or 19 sheets + 1 cover sheet (up to 300 g/m ²) |
| Booklet output capacity | Max. 35 booklets; unlimited (without tray) |
| Duty cycle (monthly) | 651i Rec. 53,000 pages; Max. ² 300,000 pages 551i Rec. 50,000 pages; Max. ² 250,000 pages 451i Rec. 40,000 pages; Max. ² 200,000 pages |
| Toner lifetime | Black up to 24,000 pages |
| Imaging unit lifetime | Black up to 260,000/1,000,000 pages (drum/developer) |
| Power consumption | 220-240 V / 50/60 Hz; Less than 1.58 kW |
| System dimension (W x D x H) | 615 x 688 x 961 mm (without options) |
| System weight | Approx. 98.0 kg (without options) |

PRINTER SPECIFICATIONS

| | |
|----------------------------------|---|
| Print resolution | 1,800 (equivalent) x 600 dpi; 1200 x 1200 dpi |
| Page description language | PCL 6 (XL3.0); PCL 5c; PostScript 3 (CPSI 3016); XPS |
| Operating systems | Windows 10 (32/64); Windows 11; Windows Server 2012; Windows Server 2012 R2; Windows Server 2016; Windows Server 2019; Windows Server 2022; macOS 10.14 or later; Unix; Linux; Citrix |
| Printer fonts | 80 PCL Latin; 137 PostScript 3 Emulation Latin; Optional: Barcode fonts; OCR A and B fonts; Unicode fonts |
| Mobile printing | AirPrint (iOS); Mopria (Android); Konica Minolta Mobile Print (iOS/Android) optional: WiFi Direct |

SCANNER SPECIFICATIONS

| | |
|--------------------------|--|
| Scan speed | 200dpi Up to 140/140 ipm in simplex (mono/colour) Up to 280/280 ipm in duplex (mono/colour) 600dpi Up to 80/75 ipm in simplex (mono/colour) Up to 160/150 ipm in duplex (mono/colour) |
| Scan resolution | Up to 600 x 600 dpi |
| Scan modes | Scan-to-eMail (Scan-to-Me); Scan-to-SMB (Scan-to-Home); Scan-to-FTP; Scan-to-Box; Scan-to-USB; Scan-to-WebDAV; Scan-to-DPWS; Scan-to-URL; TWAIN scan |
| File formats | JPEG; TIFF; PDF; Compact PDF; Encrypted PDF; XPS; Compact XPS; PPTX; PDF/A 1a and 1b optional: Searchable PDF; Searchable DOCX/PPTX/XLSX |
| Scan destinations | 2,000 destinations + 100 groups; LDAP support |

COPIER SPECIFICATIONS

| | |
|------------------------|-------------------------------------|
| Copy resolution | 600 x 600 dpi |
| Gradation | 256 gradations |
| Multicopy | 1-9,999 |
| Original format | Max. A3 |
| Magnification | 25-400% in 0.1% steps; Auto-zooming |

FAX SPECIFICATION

| | |
|-------------------------|---------------------------------------|
| Fax standard | Super G3 (optional) |
| Fax transmission | Analogue; i-Fax; Colour i-Fax; IP-Fax |
| Fax resolution | Up to 600 x 600 dpi |
| Fax compression | MH; MR; MMR; JBIG |
| Fax modem | Up to 33.6 Kbps |

FAX SPECIFICATION

| | |
|-------------------------|---------------------------|
| Fax destinations | 2,000 single + 100 groups |
|-------------------------|---------------------------|

USER BOX SPECIFICATIONS

| | |
|-----------------------------|---|
| Storable documents | Up to 3,000 documents or 10,000 pages |
| Type of user boxes | Public; Personal (with password or authentication); Group (with authentication) |
| Type of system boxes | Secure print; Encrypted PDF print; Fax receipt; Fax polling |

SYSTEM FEATURES

| | |
|-------------------|---|
| Security | ISO15408 Common Criteria (in evaluation); IP filtering and port blocking; TLS1.2/1.3 network communication; IPsec support; IEEE 802.1x support; User authentication; Authentication log; Secure print; Kerberos; Storage data overwrite; Storage data encryption (AES 256); Confidential fax; Print user data encryption optional: Antivirus realtime scanning (Bitdefender®); Copy protection (Copy Guard, Password Copy) |
| Accounting | Up to 1,000 user accounts; Active Directory support (user name + password + e-mail + smb folder); User function access definition; Authentication by mobile device (Android) optional: Biometric authentication (finger vein scanner); ID card authentication (ID card reader); Authentication by mobile device (iOS) |
| Software | Data Administrator; Web Connection; HDD Backup Utility; Driver Packaging Utility; Log Management Utility; Font Management Utility; Download Manager |

¹ Warm-up time may vary depending on the operating environment and usage

² If the maximum volume is reached within a period of one year, then a maintenance cycle must be performed

- All specifications refer to A4-size paper of 80 g/m² quality.
- The support and availability of the listed specifications and functionalities varies depending on operating systems, applications and network protocols as well as network and system configurations.
- The stated life expectancy of each consumable is based on specific operating conditions such as page coverage for a particular page size (6% coverage of A4). The actual life of each consumable will vary depending on use and other printing variables including page coverage, page size, media type, continuous or intermittent printing, ambient temperature and humidity.
- Some of the product illustrations contain optional accessories.
- Specifications and accessories are based on the information available at the time of printing and are subject to change without notice.
- Konica Minolta does not warrant that any specifications mentioned will be error-free.
- All brand and product names may be registered trademarks or trademarks of their respective holders and are hereby acknowledged.



Konica Minolta Business Solutions Asia Pte Ltd

21 Media Circle
#08-01 Infinite Studios
Singapore 138562
Tel: +65 6563 5533
Fax: +65 6561 9879
Email: sales@konicaminolta.sg
www.konicaminolta.com

PRESENCE IN THE REGION

BANGLADESH . BRUNEI . CAMBODIA . INDONESIA . LAOS . MALAYSIA . MAURITIUS . MYANMAR . PHILIPPINES . SINGAPORE . SRI LANKA . THAILAND . VIETNAM

About Konica Minolta Business Solutions Asia

Konica Minolta's journey started more than 150 years ago, with a vision to see and do things differently. We innovate for the good of society and the world. The same purpose that kept us moving then, keeps us moving now.

Konica Minolta Business Solutions Asia, based in Singapore, is a wholly owned subsidiary of Konica Minolta Inc., Tokyo, Japan. With its unique expertise in imaging, data processing and data-based decision making, Konica Minolta creates relevant solutions for its customers - small and medium-sized businesses, large enterprises and public sector - and solves issues faced by society.

As a digital workplace solution provider, Konica Minolta helps its clients to identify and unlock the potential digitalisation holds and reach the next level in the digital maturity of their organisation by rethinking the workplace. In support of an 'Intelligent connected workplace', Konica Minolta offers cloud, IT, managed print and video solution services for remote working, collaboration, workflow management and automation and security. The company's success in driving transformation is also confirmed by IDC, since the 'IDC MarketScape: Worldwide Print Transformation 2023 Vendor Assessment' has named Konica Minolta a "Leader" in print transformation. Konica Minolta has been a Microsoft Global Managed Partner since 2021.

The company has been repeatedly recognised for its rich history of social contribution as well as for working towards achieving the SDGs throughout its business and supply chain. Konica Minolta is listed among "2023 Global 100 Most Sustainable Corporations in the World" and received a GOLD Level Recognition Medal in the EcoVadis sustainability ratings for 2023.

Worldwide, the company has over 39,000 employees and is operating in over 150 countries.

For more information, please visit <https://www.konicaminolta.com/>

Our organisation is certified according to ISO27001, ISO9001 and ISO14001 standards.



Scan Me for more info !



FOR THE EARTH. FOR THE FUTURE.